

Unit 1 School Zone



1. Match, colour and say.



- Match and colour the school things.
- Say the school words.
- Trace and colour Digi's item.

   **2. Trace and colour. Say.**

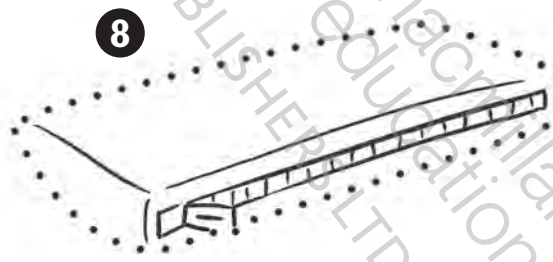
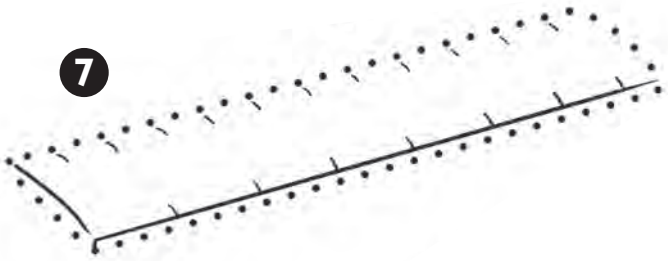
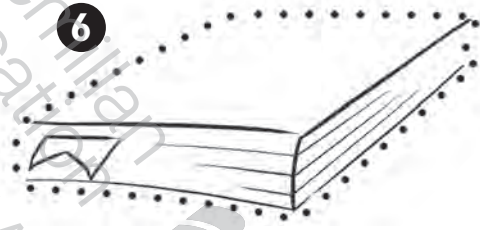
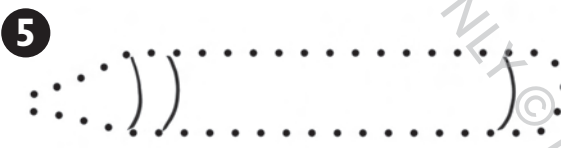
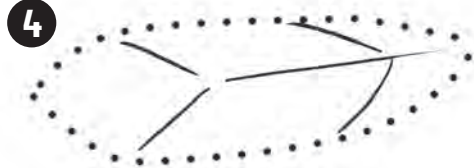
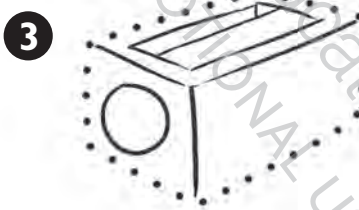
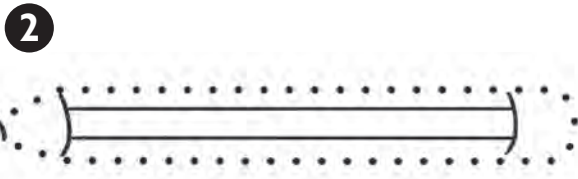
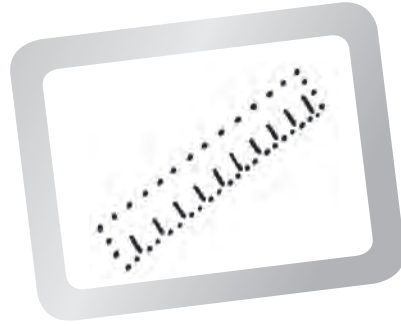
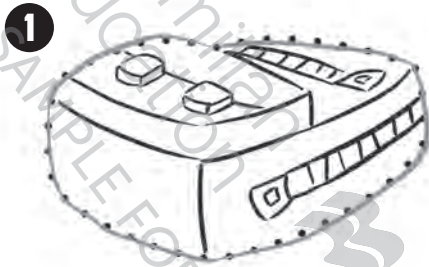

- Trace and colour the pictures of the school things.
- Look at the pictures. Say the school words.
- Trace and colour Digi's item.



3. Listen, point and colour.

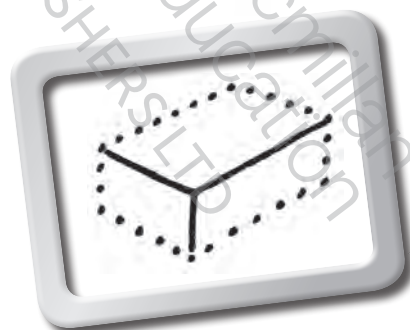
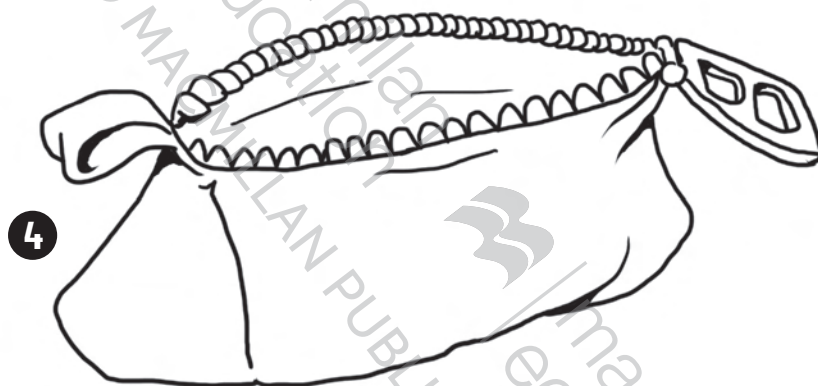
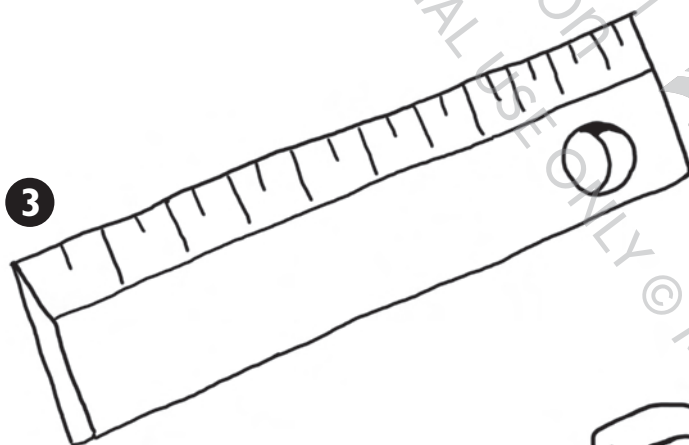
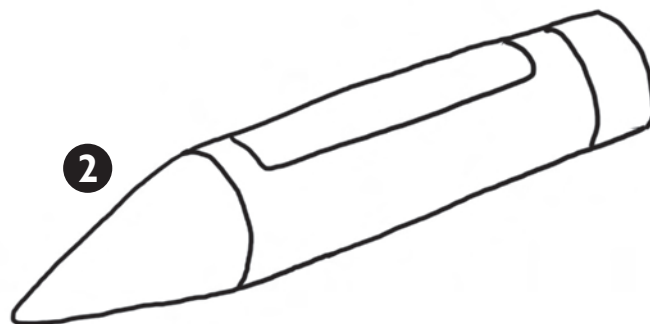

- Listen and colour the school things.
- Trace and colour Digi's item.



4. Look and match. Number and colour.

1



2



3

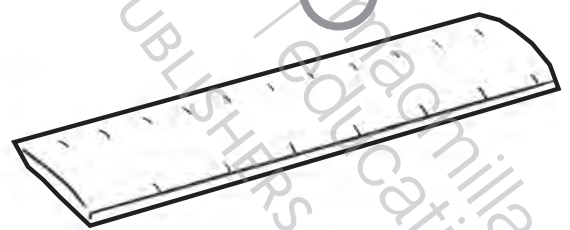
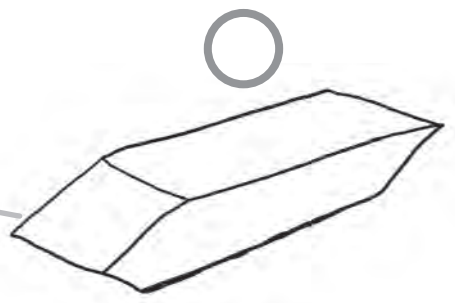

- Match school things to the story pictures.
- Number the pictures and colour the school things.
- Trace and colour Digi's item.



5. Look and circle the words with the 'p' sound. Draw.

1

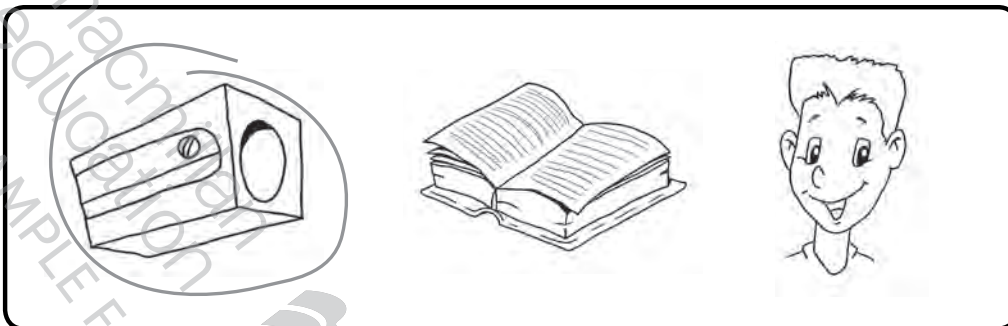

2

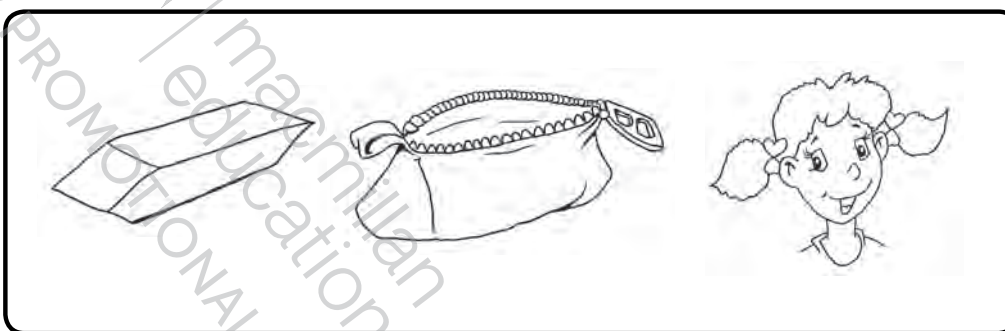

3

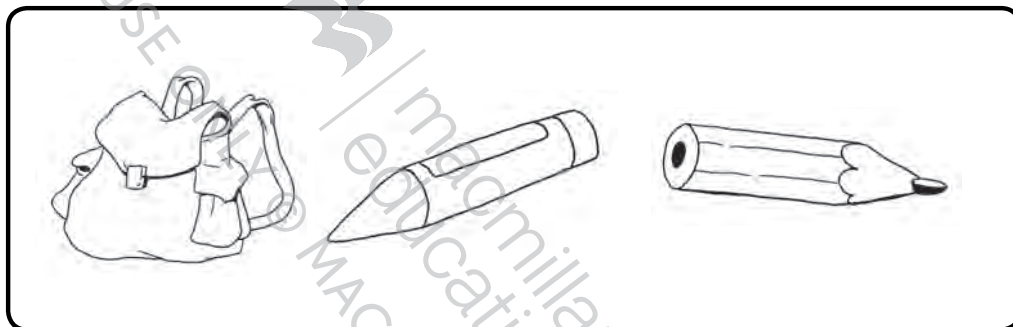

- Look and circle the 'p' words.
- Draw a school thing with a 'p' sound.
- Trace and colour Digi's item.



6. Listen and number. Act out.

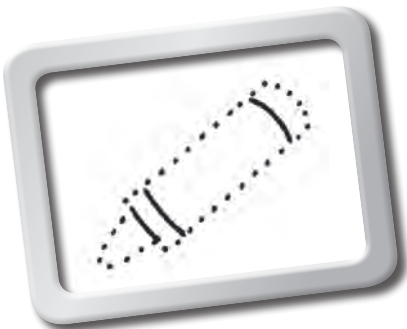
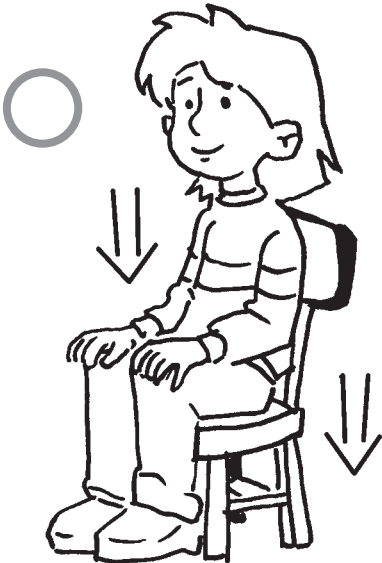
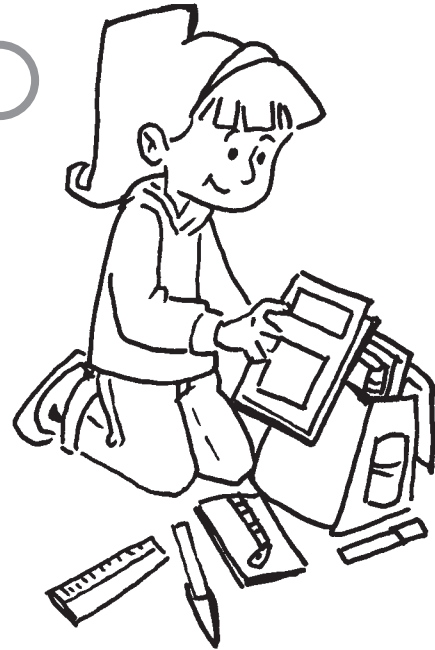

- Listen and number the pictures.
- Act out the classroom behaviour.
- Trace and colour Digi's item.



7. Listen, sing and point. Act out.

1



2



3



4



5



6



8. Draw and colour Digi's items from each page.



- Listen, sing and point to the pictures.
- Act out the *Classroom rap*.
- Draw and colour Digi's items from each page.